



SILLA DE TRASLADO  
POLTRONA DI TRASFERIMENTO

swifi®



Vers.: 12-2013



# swifi®

## HIGIENE / IGIENE

- Tapicería asiento y respaldo sin costuras
- Bastidor metálico monobloque
- Rivestimento della seduta e dello schienale senza cuciture
- Telaio metallico monoblocco

## CONFORT / COMFORT

- Canasta para la ropa integrada
- Porta-documentos integrado
- Barra de empuje en todo el ancho
- Ruedas traseras  $\varnothing$  300 mm
- Numerosos accesorios
- Cestello porta indumenti integrato
- Vano porta documento integrato
- Maniglione di spinta per tutta la larghezza
- Ruote posteriori  $\varnothing$  300 mm
- Numerosi accessori

Capacidad / Portata

  
**200 kg**



## SEGURIDAD SICUREZZA

- Capacidad 200 kg
- Ruedas traseras con frenado centralizado
- Parachoques redondos en la parte delantera
- Portata 200 kg
- Ruote posteriori con frenatura centralizzata
  - Paracolpi anteriori ad anelli

## ACCESIBILIDAD ACCESSIBILITÀ

- Apoya-brazos elevables
- Asiento abierto por ambos lados
- Reposapiés replegable
- Existe en 2 anchuras (47 y 60 cm)
- Bracciali reclinabili
- Seduta con spazio libero ai lati
- Poggiatesta retrattile
- 2 larghezze disponibili (47 e 60 cm)



## CARACTERÍSTICAS ESTÁNDAR

Ancho asientos 47 ó 60 cm  
 Estructura de chapa de acero electrocincado con acabado epoxi gris nube  
 Empuñadura de empuje acabado epoxi  
 Asiento y respaldo con revestimiento ignífugo M1, sin costuras  
 Porta documentos  
 Canasta para la ropa  
 Apoya-brazos elevable con tope  
 Reposa-piés plegable con mando bilateral  
 Parachoques redondos en la parte delantera  
 Ruedas traseras  $\varnothing$  300 mm con frenado centralizado  
 Ruedas delanteras  $\varnothing$  100 mm – rodamientos de bolas  
 Altura de asiento de 58 cm  
 Capacidad de carga: 200 kg (test en estático a 600 kg)

## CARATTERISTICHE STANDARD

Larghezza imbottitura 47 o 60 cm  
 Struttura in acciaio verniciato a polveri epossidiche di colore grigio chiaro  
 Maniglione di spinta con finitura in resina epossidica  
 Seduta e schienale con rivestimento ignifugo M1, senza cuciture  
 Vano porta documenti paziente  
 Cestello porta indumenti  
 Braccioli reclinabili con meccanismo di blocco  
 Poggiapiedi retrattile con comando bilaterale  
 Paracolpi anteriori ad anelli  
 Ruote posteriori con frenaggio centralizzato  
 Ruote anteriori  $\varnothing$  100 mm con cuscinetti a sfera  
 Altezza della seduta: 58 cm  
 Capacità di carico: 200 kg (testata in statica a 600 kg)



Modelos Modelli	Ancho 47 cm Larghezza 47 cm	Ancho 60 cm Larghezza 60 cm
30130-02	●	
30130-02L		●

## Accesorios Accessori



30149-01L  
 Reposapiernas con anclaje  
 Poggiamambe con ancoraggio  
 (para/per 30130-01L)



30141-01

Reposacabezas  
 Poggiatesta



30140-01  
 Soporte bolsa orina  
 Supporto per sacchetto urina



30142-01 + 30148-20  
 Mesilla soporte  
 Tavolina porta oggetti

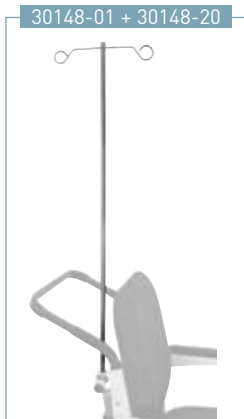

30148-01 + 30148-20  
 Varilla porta sueros 2 ganchos  
 Asta portaflebo a 2 ganci

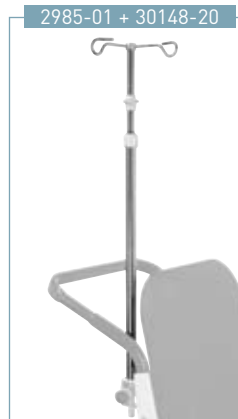

2985-01 + 30148-20  
 Varilla porta sueros  
 autobloqueante 2 ganchos  
 Asta portaflebo autobloccante  
 a 2 ganci

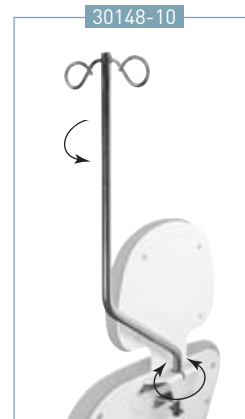

30148-10  
 Swing IV®  
 Varilla porta sueros rotativa  
 Asta portaflebo girevole



30143-01  
 Cinturón de sujeción  
 Cintura di sicurezza

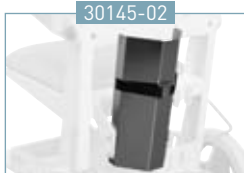

30145-02  
 Soporte botella oxígeno  
 (ø max. 160 x alt. 620)  
 Supporto per bombola ossigeno  
 (ø massimo 160 x alt. 620)

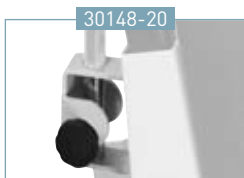

30148-20  
 Fijador  $\varnothing$  16mm  
 Morsetto  $\varnothing$  16 mm

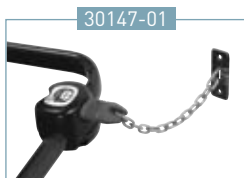

30147-01  
 Consigna con monedas (1 €)  
 con fijación mural  
 Gettoniera a monete (1 €)  
 con fissaggio a muro



30147-10  
 Consigna especial con 10 fichas  
 con fijación mural  
 Gettoniera speciale  
 con fissaggio a muro,  
 completa di 10 gettoni



30147-20  
 Juego de 10 fichas  
 Set di 10 gettoni  
 (para/per 30147-10)

Colores de tapizado disponibles,  
ignífugo clase M1 - Antibacterias  
Colori disponibili per i rivestimenti  
ignifughi M1 - Antibatterici

Classic

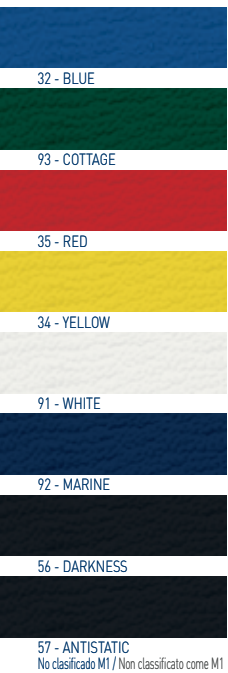

Vitamin

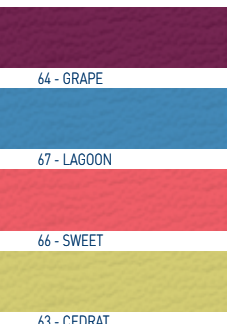

Cosy

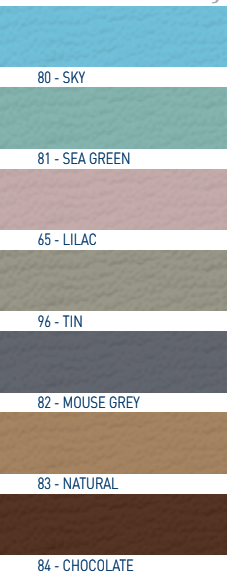

Tapicerías RITTER  
Rivestimenti RITTER  
No clasificado M1  
Non classificato come M1

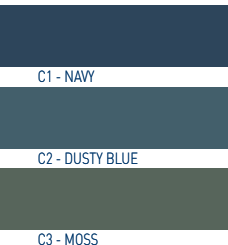

ANTIBACTERIAS / IGNÍFUGO M1 - MATERIALE ANTIBATTERICO / IGNIFUGO M1



**30130-02**  
Peso neto  
Peso netto  
37 kg  
Peso bruto  
Peso lordo  
42 kg  
(+ palet/paletta = + 15 kg)  
Volumen / Volume  
0,90 m<sup>3</sup>  
(+ palet/paletta = 1 m<sup>3</sup>)

---

**30130-02L**  
Peso neto  
Peso netto  
44 kg  
Peso bruto  
Peso lordo  
50 kg  
(+ palet/paletta = + 15 kg)  
Volumen / Volume  
1,22 m<sup>3</sup>  
(+ palet/paletta = 1,350 m<sup>3</sup>)

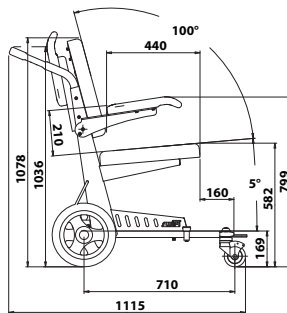
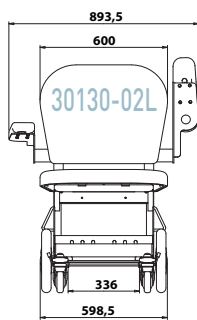
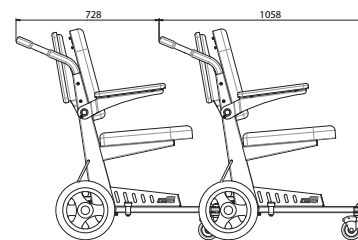
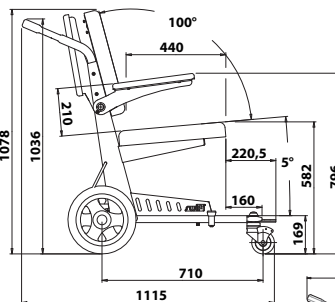
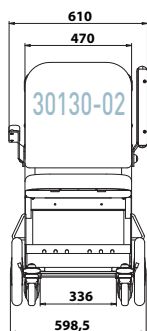

EI-49/13

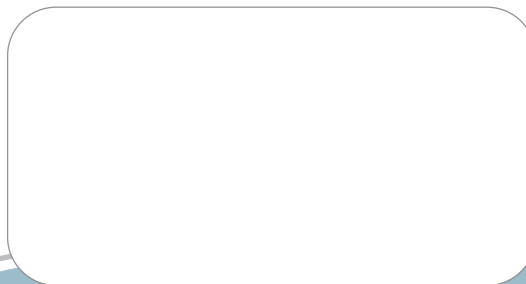

Midmark Europe SAS  
22, rue de Saint-Denis - 53500 Ernée  
www.promotal.com

